

Customer Experience Center
1-800-331-4331

www.toyotaownersonline.com



moving forward ▶

4Runner



2006
Pocket Reference Guide

MN 00452-PRG06-4RUN
Printed in USA 08/05

2006 4Runner

This Pocket Reference Guide is a summary of basic vehicle operations. It contains brief descriptions of fundamental operations so you can locate and use the vehicle's main equipment quickly and easily.

The Pocket Reference Guide is not intended as a substitute for the Owner's Manual located in the vehicle's glove box. We strongly encourage you to review the Owner's Manual and supplementary manuals so you will have a better understanding of the vehicle's capabilities and limitations.

Your dealership and the entire staff of Toyota Motor Sales, U.S.A., Inc., wish you many years of satisfied driving in your new 4Runner.

! A word about safe vehicle operations

This Pocket Reference Guide is not a full description of 4Runner operations. Every 4Runner owner should review the Owner's Manual that accompanies this vehicle.

Pay special attention to the boxed " **CAUTION** " information highlighted in this reference guide and throughout the Owner's Manual. Each box contains safe operating instructions to help you avoid injury or equipment malfunction.

CAUTION

This utility vehicle has a significantly higher rollover rate than other types of vehicles. Refer to the Owner's Manual for important rollover information.

All information in this Pocket Reference Guide is current at the time of printing. Toyota reserves the right to make changes at any time without notice.

Spare tire & tools

Tool location

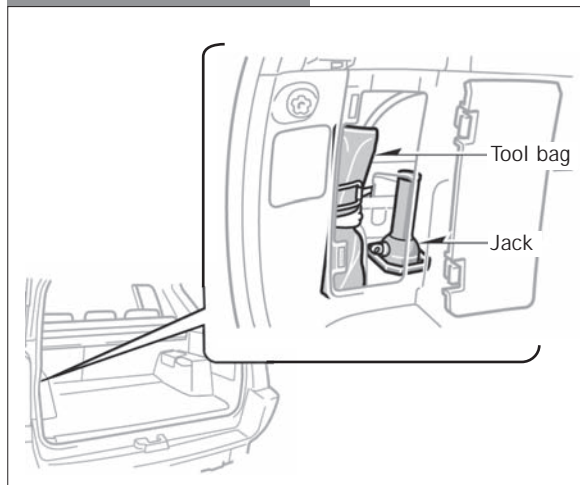

Removing the spare tire

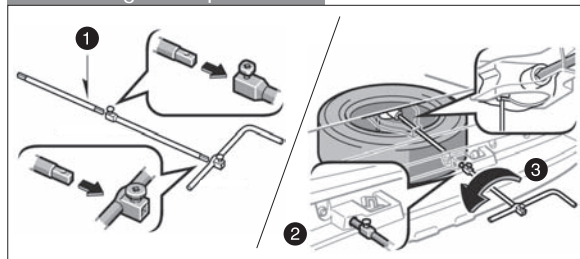

- 1 Assemble the jack handle.
- 2 Insert the jack handle end through the opening in the bumper, and into the lowering screw.
- 3 Turn the jack handle counterclockwise.

Refer to the Owner's Manual for jack positioning and tire changing procedures.

INDEX

Item	Page no.
OVERVIEW	
Engine maintenance	7
Fuel tank door release and cap	6
Hood release	6
Indicator symbols	4-5
Instrument cluster	4
Instrument panel	2-3
Keyless entry ²	8
FEATURES/OPERATIONS	
Air conditioning/Heating	17
Audio	18-19
Auto lock functions ^{1, 2}	9
Auto LSD (Auto Limited Slip Differential)	21
Automatic transmission	9
Bottle holders	20
Clock	14
Cruise control	16
Cup holders	21
Door locks	20
Four-wheel drive	10
Garage door opener (HomeLink [®]) ³	16
Light control-Instrument panel	11
Lights ² & turn signals	14
Moonroof ²	22
Power outlets	22
Rear seat entertainment system	20
Seat adjustments-Front	11
Seat adjustments-Rear	12
Seat heaters	22
Seats-Head restraints	11
Tilt and telescopic steering wheel	13
Windows ²	15
Window-Back ²	15
Windshield wiper & washer	13
SAFETY AND EMERGENCY FEATURES	
Doors-Child safety locks	23
Parking brake	24
Seat belts	23
Seat belts-Shoulder belt anchor	24
Spare tire & tools	25
Tire Pressure Warning System	24

¹ Programmable by customer. Refer to the Owner's Manual for instructions and more information.

² Visit your Toyota dealer for information on this and other customizable options.

³ HomeLink[®] is a registered trademark of Johnson Controls, Inc.

OVERVIEW

Instrument panel

Steering wheel switches (if equipped)

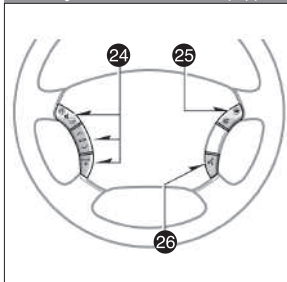

Rear console box

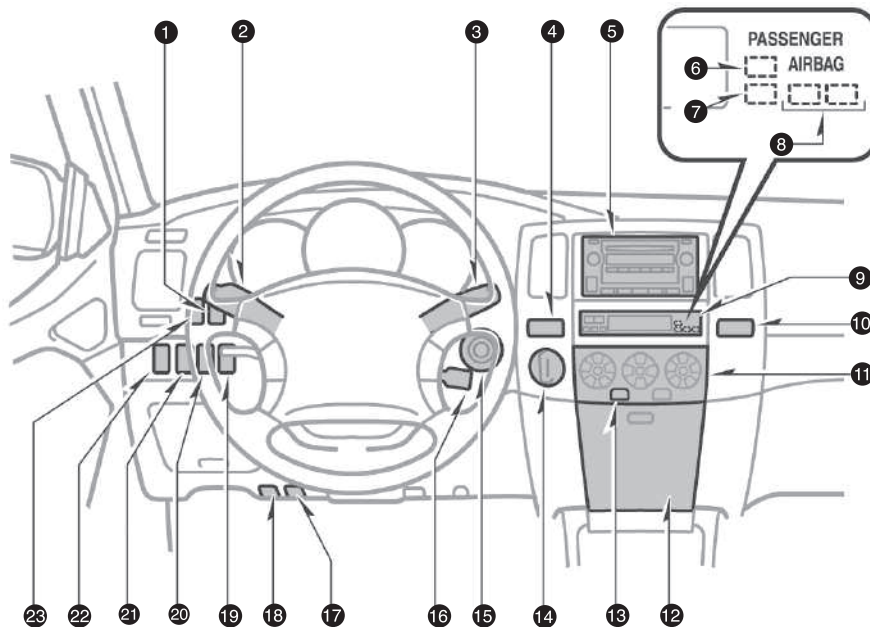
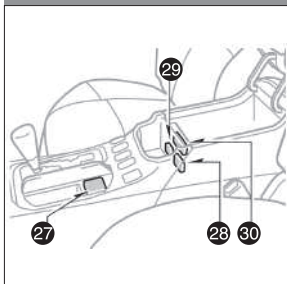

- 1 Driving position memory switches¹
- 2 Headlight, turn signal and front fog light¹ control
- 3 Wiper and washer controls
- 4 Power back window switch
- 5 Audio or navigation system^{1,2}
- 6 Front passenger's seat belt reminder light
- 7 Engine immobilizer/Theft deterrent system indicator light¹
- 8 Front passenger occupant classification indicator lights
- 9 Multi-information display
- 10 Emergency flasher switch
- 11 Air conditioning controls
- 12 Auxiliary box
- 13 Back window and outside rearview mirror defogger¹ switch
- 14 Four-wheel drive selector¹ (full-time 4WD models) or two wheel/four-wheel drive selector¹ (part-time 4WD models)
- 15 Ignition
- 16 Cruise control
- 17 Hood release
- 18 Fuel tank door opener
- 19 "RSCA OFF" (Roll Sensing of Curtain shield Airbags "OFF") switch¹
- 20 "AUTO LSD" switch¹
- 21 Center differential lock switch¹
- 22 115V AC Power outlet ON/OFF switch¹
- 23 Instrument panel light control
- 24 Audio steering wheel switches^{1,2}
- 25 Telephone switches^{1,2}
- 26 Speech command switch^{1,2}
- 27 12V DC Power outlet/Cigarette lighter
- 28 115V AC Power outlet¹
- 29 AUX adapter
- 30 A/V input adapter¹

¹If equipped

²For details, refer to the Navigation System Owner's Manual.

Instrument cluster

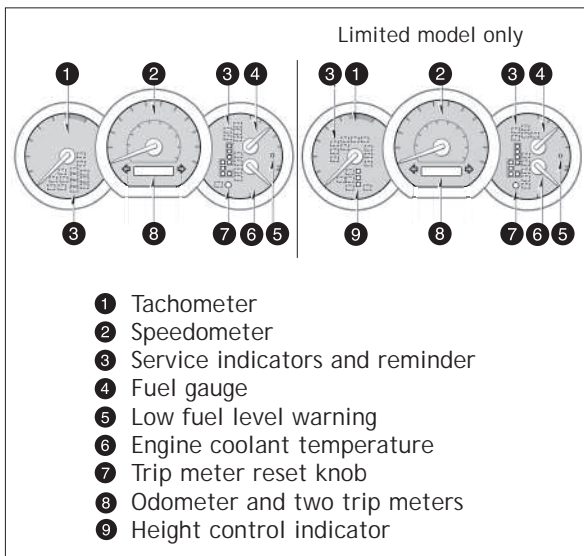

Indicator symbols

	Brake system warning ¹
	Driver's/Front passenger's seat belt reminder ¹
	Battery warning ¹
	Low engine oil pressure warning ¹
	Malfunction/Check Engine indicator ¹
	Engine oil replacement reminder ¹
	<ul style="list-style-type: none"> • Vehicle Stability Control warning¹ • "AUTO LSD" warning¹ • Traction Control warning¹ • Downhill Assist Control warning¹ • Active Traction Control warning¹ • Hill-start Assist Control warning¹
	Open door warning ¹
	Airbag SRS warning ¹

¹ For details, refer to "Service reminder indicators and warning buzzers," Section 1-6, 2006 Owner's Manual.

² For details, see "Roll sensing of curtain shield airbags off switch," Section 1-3, 2006 Owner's Manual.

³ If this light flashes, refer to "Four-wheel drive system," Section

	Automatic transmission fluid temperature warning ¹
	Low Tire Pressure Warning ¹
	Theft deterrent/Engine immobilizer system indicator
	Roll Sensing of Curtain shield Airbag "OFF" indicator ^{1,2}
	Front passenger occupant classification indicator
	Headlight low/high beam indicator
	Turn signal indicator
	Front fog light indicator
	Automatic transmission indicator
	Low speed four-wheel drive indicator ³
	Center differential lock indicator ³
	Vehicle Stability Control "OFF" indicator
	Four-wheel drive indicator ³
	Slip indicator
	"AUTO LSD" indicator
	Downhill Assist Control indicator
	Height control indicator
	Height control "OFF" indicator ⁴
	Cruise control indicator ⁵
	Anti-lock Brake System warning ¹

CAUTION

When the Anti-lock Brake System (ABS) function is in action, you may feel the brake pedal pulsating and hear a noise. In this situation, to let the Anti-lock Brake System work for you, just hold the brake pedal down more firmly. Do not pump the brake as this will result in reduced braking performance.

1-7, 2006 Owner's Manual.

⁴ If this light flashes, refer to "Rear height control air suspension," Section 1-7, 2006 Owner's Manual.

⁵ If this light flashes, refer to "Cruise control," Section 1-7, 2006 Owner's Manual.

Fuel tank door release and cap

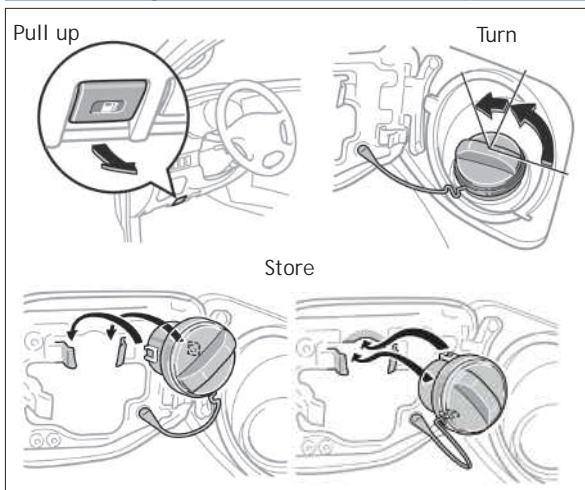

NOTE: If the cap is not tightened enough, Check Engine "CHECK" indicator may illuminate.

Hood release

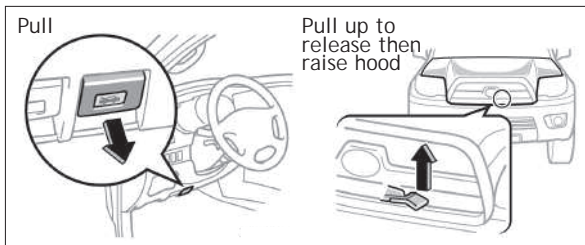

Engine maintenance

6 cylinder (1GR-FE) engine

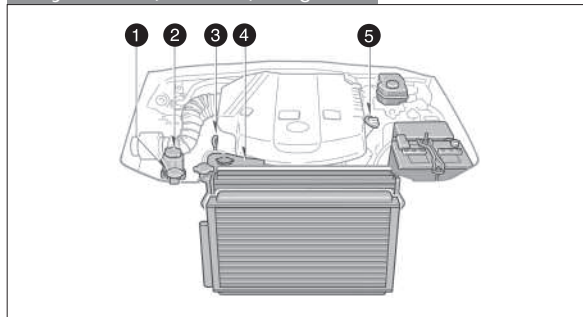

8 cylinder (2UZ-FE) engine

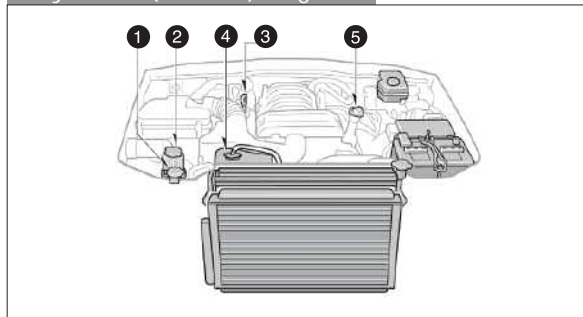

- 1 Windshield and back window washer fluid tank
- 2 Power steering fluid reservoir
- 3 Engine oil level dipstick
- 4 Engine coolant reservoir
- 5 Engine oil filler cap

Note: Regularly scheduled maintenance, including oil changes, will help extend the life of your vehicle and maintain performance. Please refer to the "Owner's Warranty Information Booklet," "Scheduled Maintenance Guide" or "Owner's Manual Supplement."

Keyless entry (if equipped)

Beep sound can be switched "ON" or "OFF" by consumer. Refer to the Owner's Manual for more details.

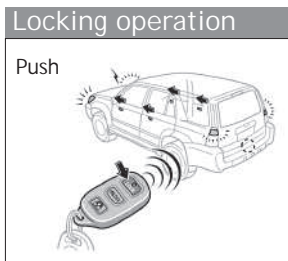

NOTE: After unlocking, if a door is not opened within thirty (30) seconds, all doors will relock for safety.

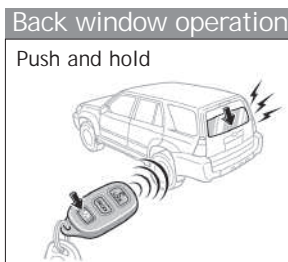

Auto lock functions

Automatic door locks can be programmed by customer to operate in 4 different modes.

- Doors lock when shifting from Park.
- Doors lock when the vehicle speed exceeds 12 mph.
- Doors unlock when the ignition key is turned to the "ACC" or "LOCK" position and driver's door is opened.
- Doors unlock when shifting into Park.

Automatic transmission

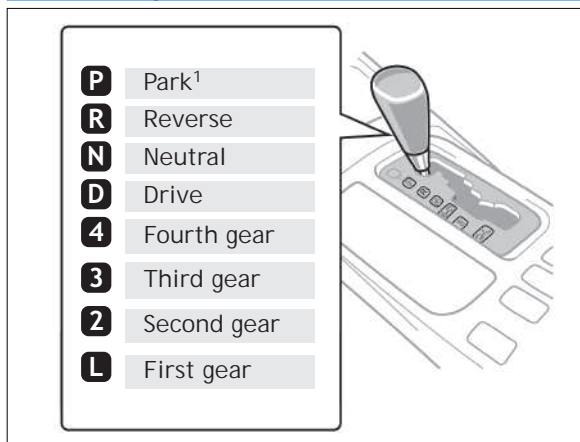

¹The key must be in the "ON" or "ACC" position and the brake pedal depressed.

Downshifting increases power going uphill, or provides engine braking downhill. For best fuel economy during normal driving conditions, always drive with the shift lever in the "D" position.

Four-wheel drive (if equipped)

Part-time four-wheel drive models

- H2** High speed (2WD)
- H4** High speed (4WD)
Turn to "H4" with speed below 62 mph.
- L4** Low speed (4WD)
Shift to "N" position, then push and turn to "L4."

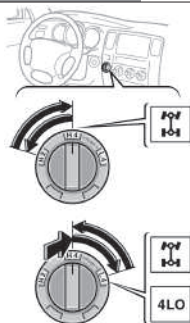

Full-time four-wheel drive models

- H4** High speed
Turn to "H4" with speed below 62 mph.
- L4** Low speed
Shift to "N" position, then push and turn to "L4."

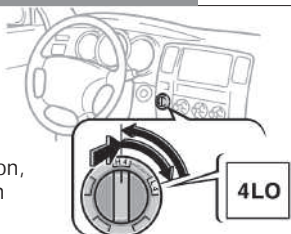

Center differential lock button



Center differential lock/unlock

For best fuel economy and performance under normal driving conditions:

- "H2" position (part-time four-wheel drive models)
 - "H4" position (full-time four-wheel drive models),
- Center differential unlocked (Center differential lock and "VSC OFF" indicator lights are not illuminated).

Light control-Instrument panel

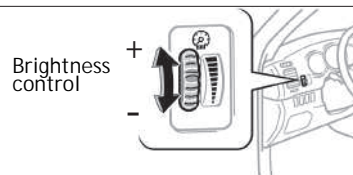

Seat adjustments-Front

Manual Seat

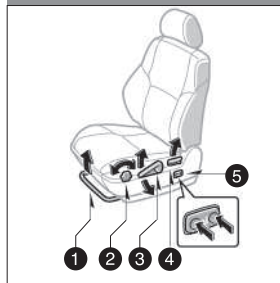

Power Seat



- 1 Position
- 2 Cushion angle
- 3 Height crank (driver side only)
- 4 Seatback angle
- 5 Lumbar support
- 6 Driver's seat: position and cushion angle/height
Passenger's seat: position
- 7 Seatback angle
- 8 Lumbar support

Seats-Head restraints

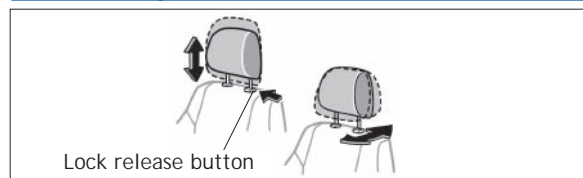

Seat adjustments-Rear (Vehicles with third row seats)

Second row seats



Third row seats



Seat adjustments-Rear (Vehicles without third row seats)

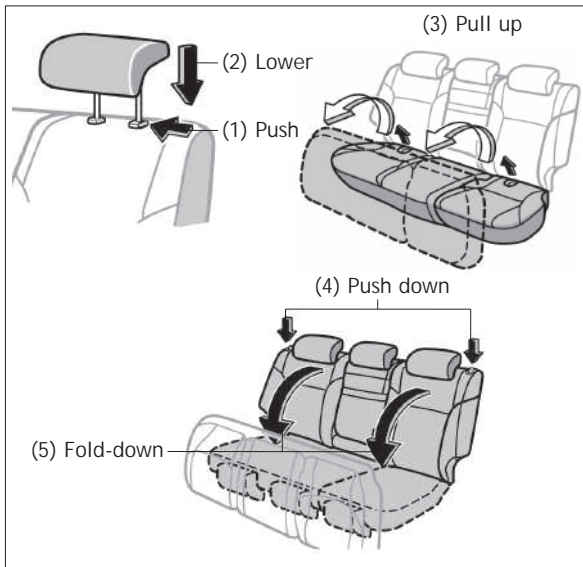

Windshield wiper & washer

Front

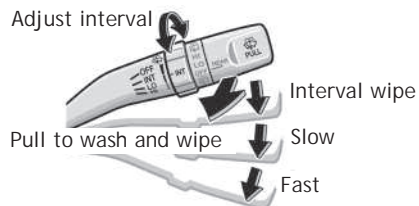

Rear

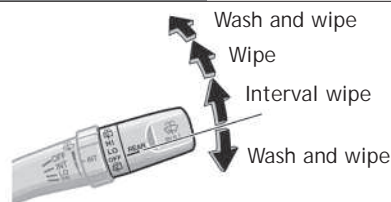

NOTE: Rear wiper and washer operate only when rear window is fully closed. If battery is disconnected, rear washer will not function until rear window is reinitialized by fully opening and closing rear window.

Tilt and telescopic (if equipped) steering wheel

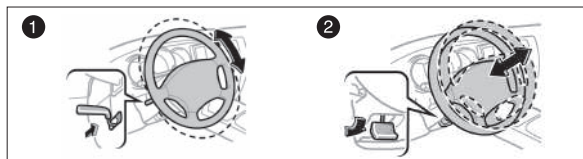

- 1 To change the angle Hold the steering wheel, pull the lock release lever, tilt to the desired angle then release the lever.
- 2 To change the column length Push the lock release lever down, set the desired length, and return the lever to its locked position.

Note: Do not attempt to adjust while the vehicle is in motion.

Lights & turn signals

Headlights

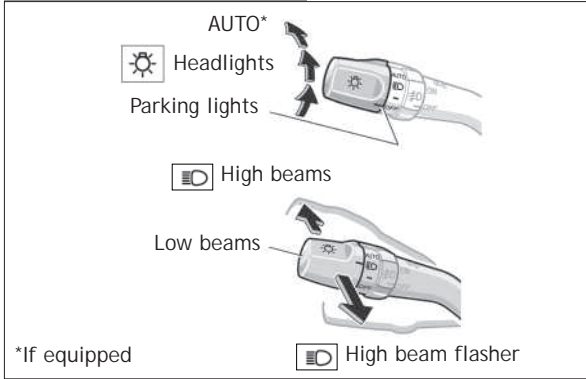

-Automatic light cutoff system Automatically turns lights off after 30 seconds when the driver's door is opened and closed with the key in "ACC" or "LOCK." Lights may also be turned off by pushing lock button on remote twice.

-Daytime Running Light system (if equipped) Automatically turns on the headlights at a reduced intensity.

Turn signals

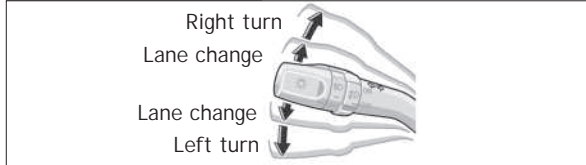

Front fog lights (if equipped)



Front fog lights come on only when the headlights are on low beam.

Clock

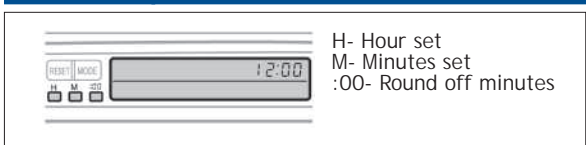

Windows

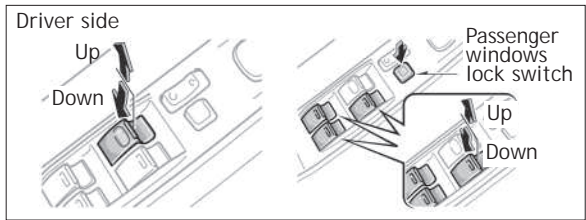

Automatic operation (Driver side only) Push the switch completely down or pull it completely up and release to fully open or close. To stop window midway, lightly push the switch in the opposite direction.

NOTE: If the battery is disconnected, windows need to be reinitialized. Refer to the Owner's Manual for more details.

Window-Back

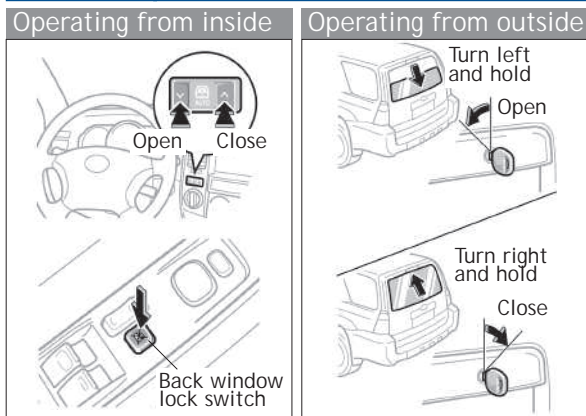

NOTE: If the battery is disconnected, the rear window needs to be reinitialized. Refer to the Owner's Manual for more details.

Cruise control

Turning system ON/OFF

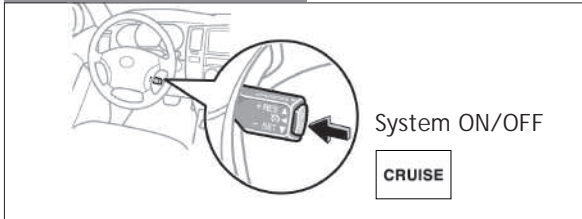

Functions

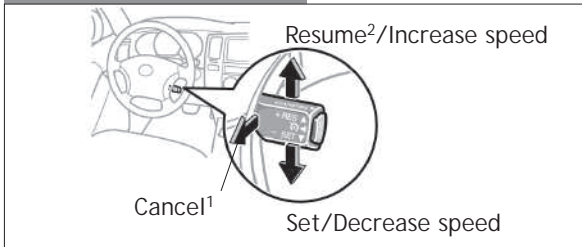

¹ The set speed may also be cancelled by depressing the brake pedal.

² The set speed may be resumed once vehicle speed exceeds 25 mph.

Garage door opener (HomeLink®)* (if equipped)

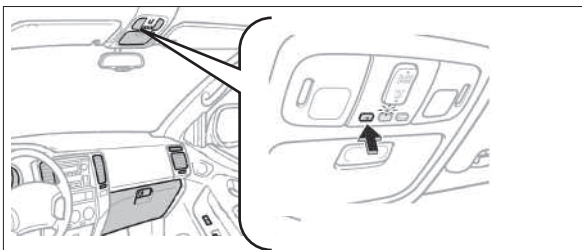

Garage door openers manufactured under license from HomeLink®** can be programmed to operate garage doors, estate gates, security lighting, etc.

Refer to the Owner's Manual for more details. For programming assistance, contact the Toyota Customer Experience Center at 1-800-331-4331, or visit <http://www.homelink.com>

*HomeLink® is a registered trademark of Johnson Controls, Inc.

Air conditioning/Heating

Without "DUAL" button

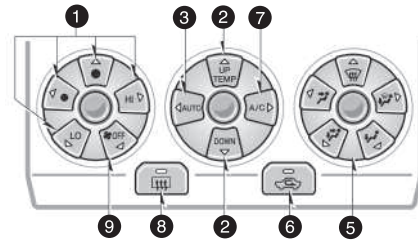

With "DUAL" button (if equipped)

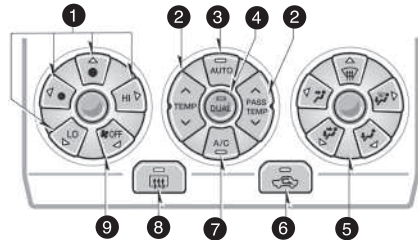

- 1 Fan speed
- 2 Temperature
- 3 Automatic climate control ON/OFF
- 4 "DUAL" button
- 5 Air flow vent selector¹
- 6 Fresh or recirculate cabin air
- 7 Air Conditioning ON/OFF
- 8 Rear defogger
- 9 Climate control OFF

¹ In " " or " " mode, use fresh air (" " indicator ON) to reduce window fogging.

Audio

Preset buttons - button functions in other modes indicated above number.

Eject CD

Push to turn ON/OFF

Seek station/ CD track select

Station/CD track scan

Mode

View radio and CD information

Push to adjust tone & balance

Push to skip up/down folder

Type 2 other functions:

Load CD(s)

View genre/ Push to skip up/down folder

Type 3 other functions:

RADIO

Preset buttons Tune in the desired station and press a preset button (1-6) until you hear a beep. Push desired preset button (1-6) to select. "SCAN" Push and hold "SCAN" to scan preset stations. Push again to hold selection.

Steering wheel switches (if equipped)

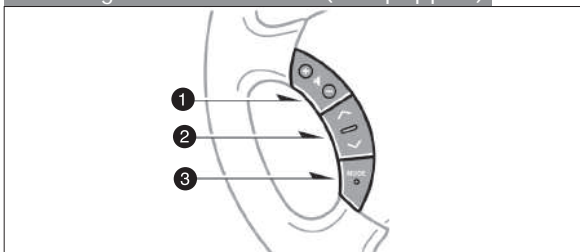

- 1 " - + " Volume control
- 2 " ^ ∨ " -In radio mode Push to select a preset station, push and hold to seek the next strong station. -In CD mode Push to skip up or down to the next or previous track.
- 3 " MODE " Push to turn audio on and select an audio mode. Push and hold to turn the audio "OFF."

CD PLAYER

To scan tracks on a disc Push "SCAN." Push again to hold selection.

CD Changer (Type 2 and 3)

- To load one disc Push "LOAD" and insert 1 disc.
- To load multiple discs Push and hold "LOAD" until you hear a beep. Insert one disc. Shutter will close and then re-open for next disc.

To select a file (MP3/WMA only) Turn "TUNE·FILE" to file up/down.

To select a folder (MP3/WMA only) Push either side of "FOLDER" or "TYPE/FOLDER."

AUX adapter

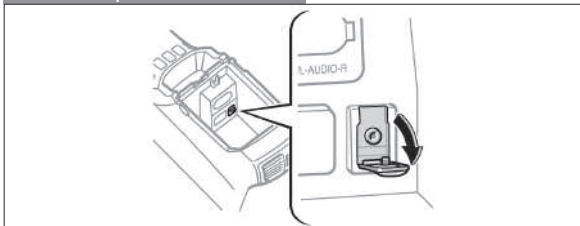

By inserting a mini plug of a commercially available component into the AUX adapter, you can listen to music from a portable audio device through the vehicle's speaker system.

Rear seat entertainment system (if equipped)

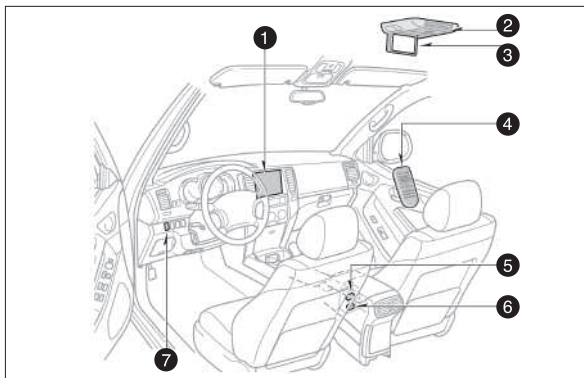

- ❶ Front audio
- ❷ DVD player
- ❸ DVD Screen
- ❹ Remote control
- ❺ A/V input adapter
- ❻ 115V AC Power outlet
- ❼ 115V AC Power outlet ON/OFF switch

Bottle holders

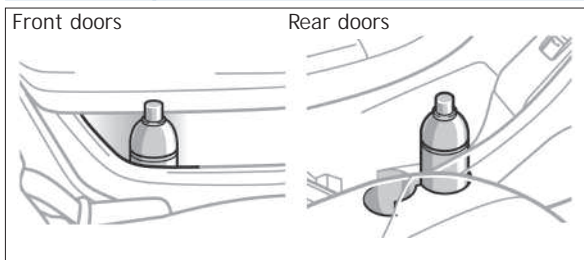

Door locks

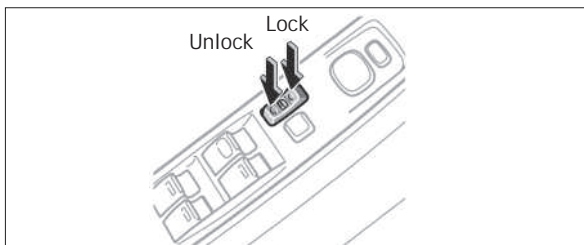

Cup holders

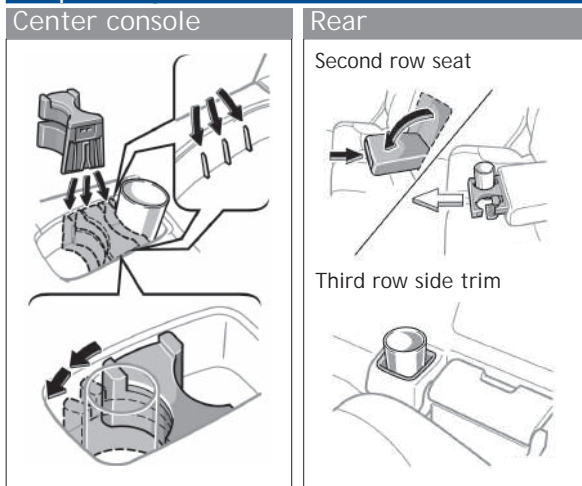

Auto LSD (Limited Slip Differential) (if equipped)

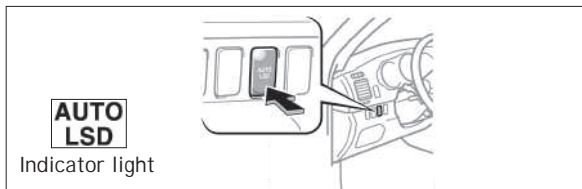

Push the “AUTO LSD” switch when the vehicle is stopped. To deactivate, push the switch again.
NOTE: It will **ONLY** work in 2-wheel drive. It should **ONLY** be used when wheel spinning occurs on slippery or unpaved surfaces.

Refer to the Owner’s Manual for complete details on this system before attempting to use it.

Moonroof (if equipped)

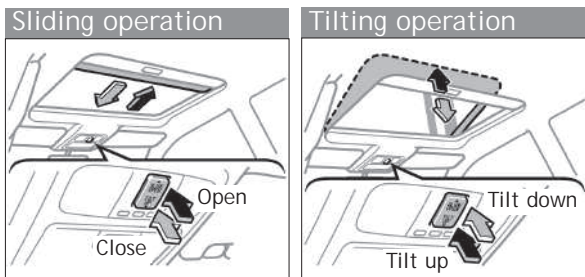

If battery is disconnected, the moonroof needs to be reinitialized. Refer to the Owner's Manual for more details.

Seat heaters

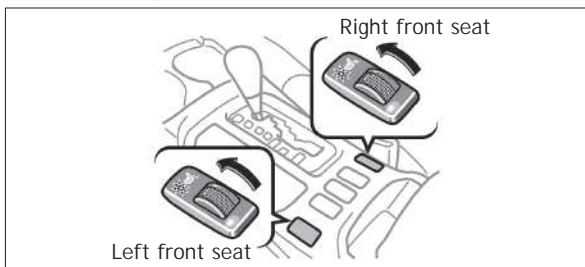

Power outlets

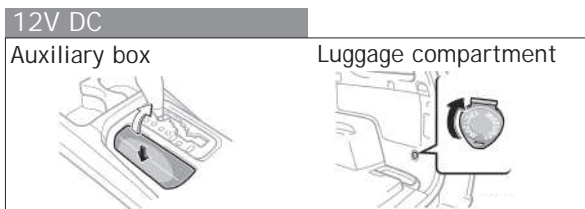

115V AC (if equipped)

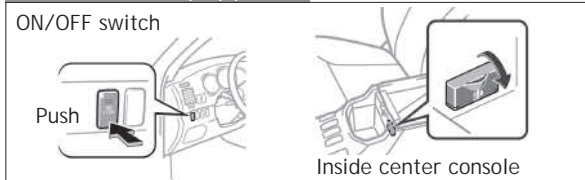

SAFETY AND EMERGENCY FEATURES

Doors-Child safety locks

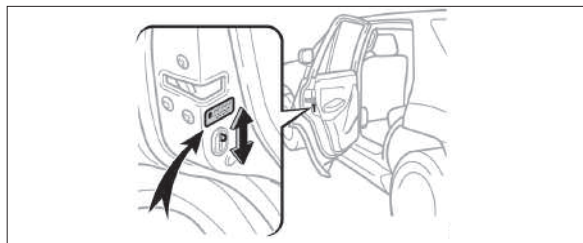

Move the lever to "LOCK," allowing the door to be opened only from the outside.

Seat belts

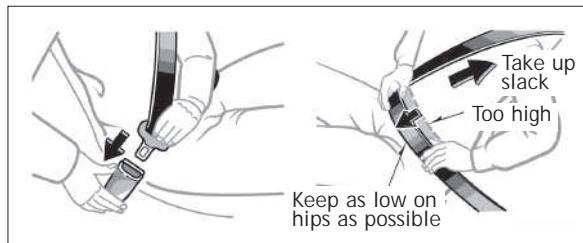

If belt is fully extended, then retracted even slightly, it cannot be re-extended beyond that point, unless fully retracted again. This feature is used to help hold child restraint systems securely.

To find more information about seat belts, and how to install a child restraint system, refer to the Owner's Manual.

SAFETY AND EMERGENCY FEATURES

Seat belts-Shoulder belt anchor

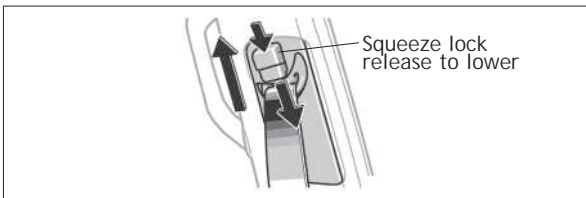

Parking brake

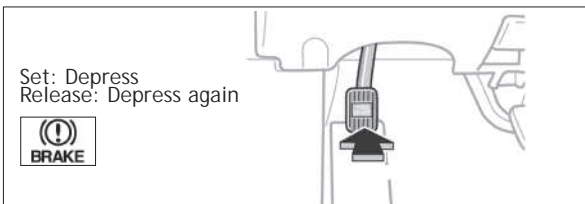

Tire Pressure Warning System

The system is designed to provide a warning when tire pressure of any one of the tires (including the spare) is reduced.

Refer to the Owner's Manual for more details.